

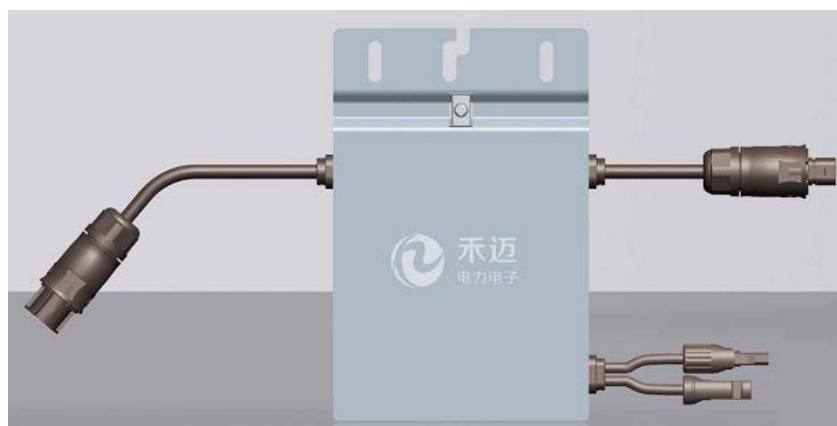

HOYMILES

MICRO-IVERTER

MI-250



TECHNICAL MANUAL

CONTENTS

INTRODUCTION.....	3
SAFETY.....	4
SYMBOL ILLUSTRATION.....	4
INSTALLATION WARNINGS	5
PREPARE FOR INSTALLING.....	6
TRANSPORT AND INSPECT	6
CHECK INSTALLATION ENVIRONMENT	7
INSTALLATION POSITION	7
MOUNTING AND WIRING.....	8
INSTALLING DIAGRAM	8
ASSEMBLY INSTRUCTION	9
Step 1. Install Micro-inverter	9
Step 2. Connect AC Cable of Micro-inverter	9
Step 3. Protecting Unused Ends	9
Step 4. Connecting AC-TRUNK Cables to Junction Box.....	10
Step 5. Drawing System Map.....	11
Step 6. Install Photovoltaic Modules.....	11
Step 7. Install CDD.....	12
MAINTENANCE GUIDE	13
ROUTINE MAINTENANCE	13
STORAGE AND DISMANTLING	14
APPENDIX	15
TECHNICAL DATA	15
EFFICIENCY CURVES	错误!未定义书签。
TEMPLATE FOR MAP OF MICRO-INVERTER INSTALLATION.....	16

INTRODUCTION

Thank you for using **MI-250** Micro-Inverter! This **Micro-Inverter system** is the world's most technologically advanced inverter system with benefits of efficient, flexible, safe and reliable for use in utility-interactive applications.

This system is composed of a group of Micro-inverters that convert direct current (DC) into alternating current (AC) and feeds it into the electric grid. Different from systems that photovoltaic modules are subdivided into strings and controlled by one or several inverters, this system is built for the incorporation of a Micro-inverter for each photovoltaic module. Each Micro-inverter works independently of the others to guarantee maximum power of each photovoltaic module. This setup enables direct control over the production of a single photovoltaic module, consequently improving the flexibility and reliability of the system.

This manual contains important instructions for the **MI-250** Micro-inverter and must be read in its entirety before installing or commissioning the equipment. For safety, only qualified technician, who has received training or has demonstrated skills can install and maintain this Micro-inverter under the guide of this document.

There are two models of the Micro-inverter, delineated by the maximum output power.

This document applies only to the inverter models listed in Table 1 below:

Table 1

Output Power	Model Number
250W	MI-250
500W	MI-500

Hoymiles can provide commissioning. Please contact Hoymiles customer service at 086-0571-89775158. More information at website: <http://www.hzconverter.com/cn/index.php>



SAFETY

IMPORTANT SAFETY INSTRUCTIONS!

PLEASE KEEP THIS INTRODUCTION IN A SAFE PLACE!

SYMBOL ILLUSTRATION

The safety symbols used in this manual are list below and illustrated in detail.

Symbol	Usage
 No DANGER	Indicates a hazardous situation that can result in deadly electric shock hazards, other serious physical injury, or fire hazards.
 WARNING	Indicates directions which must be fully understood and followed in entirety in order to avoid potential safety hazards including equipment damage or personal injury.
 CAUTION	This points out that the described operation must not be carried out. The reader should stop, use caution and fully understand the operations explained before proceeding.

INSTALLATION WARNINGS

The **MI-250/500** Micro-inverter is designed and tested according to international safety requirements (**IEC 62109-1/2; VDE4105/0126**). However, certain safety precautions must be taken when installing and operating this inverter. The installer must read and follow all instructions, cautions and warnings in this installation manual

 <p>CAUTION</p>	<ul style="list-style-type: none"> ➤ All operations including transport, installation, start-up and maintenance, must be carried out by qualified, trained personnel.
	<ul style="list-style-type: none"> ➤ Before installation, check the unit to ensure absence of any transport or handling damage, which could affect insulation integrity or safety clearances. Choose installation location carefully and adhere to specified cooling requirements. Unauthorized removal of necessary protections, improper use, incorrect installation and operation may lead to serious safety and shock hazards or equipment damage.
	<ul style="list-style-type: none"> ➤ Before connecting the Micro-inverter to the power distribution grid, contact the local power distribution grid company to get appropriate approvals. This connection must be made only by qualified technical personnel. It is the responsibility of the installer to provide external disconnect switches and Overcurrent Protection Devices (OCPD).
	<ul style="list-style-type: none"> ➤ Only one photovoltaic module can be connected in the input of the inverter. Do not connect batteries or other sources of power supply. The inverter can be used only if all the technical characteristics are observed and applied.
	<ul style="list-style-type: none"> ➤ Do not install the equipment in adverse environment conditions such as flammable, explosive, corrosive, extreme high or low temperature, and humid. Do not use the equipment when the safety devices do not work or disabled.
	<ul style="list-style-type: none"> ➤ Use personal protective equipment, including gloves and eye protection when working.
	<ul style="list-style-type: none"> ➤ Inform the manufacturer about non-standard installation conditions.
	<ul style="list-style-type: none"> ➤ Do not use the equipment if any operating anomalies are found. Avoid temporary repairs.
	<ul style="list-style-type: none"> ➤ All repairs should be carried out using only qualified spare parts, which must be installed in accordance with their intended use and by a licensed contractor or authorized Hoymiles service representative.
	<ul style="list-style-type: none"> ➤ Liabilities arising from commercial components are delegated to their respective manufacturers.
	<ul style="list-style-type: none"> ➤ Anytime the inverter has been disconnected from the power network, use extreme caution as some components can retain charge sufficient to create a shock hazard. Prior to touching any part of the inverter use care to ensure surfaces and equipment are at touch safe temperatures and voltage potentials before proceeding.
	<ul style="list-style-type: none"> ➤ Hoymiles accepts No liability for damage from incorrect or careless operation

PREPARE FOR INSTALLING

TRANSPORT AND INSPECT

Hoymiles packages and protects individual components using suitable means to make the transport and subsequent handling easier. Transportation of the equipment, especially by road, must be carried out by suitable ways for protecting the components (in particular, the electronic components) from violent, shocks, humidity, vibration, etc. Please dispose the packaging elements in appropriate ways to avoid unforeseen injury.

It is the customer's responsibility to examine the condition of the components transported. Once receiving the Micro-inverter, it is necessary to check the container for any external damage and verify receipt of all items. Call the delivering carrier immediately if damage or shortage is detected. If inspection reveals damage to the inverter, contact the supplier, or authorized distributor for a repair/return determination and instructions regarding the process.

Components supplied by **Hoymiles** are list in Table 2 below:

Table 2

Code	Description
AC trunk end cap 	End cap for 10 AWG AC cable

CHECK INSTALLATION ENVIRONMENT

Installation of the equipment is carried out based on the system design and the place in which the equipment is installed.

- The installation must be carried out with the equipment disconnected from the grid (power disconnect switch open) and with the photovoltaic modules shaded or isolated.
- See Appendix: Technical Data to check the environmental parameters to be observed (degree of protection, temperature, humidity, altitude, etc.)
- To avoid unwanted power derating due to an increase in the internal temperature of the inverter, do not expose it to direct sunlight.
- To avoid overheating, always make sure the flow of air around the inverter is not blocked.
- Do not install in places where gasses or flammable substances may be present.
- Avoid electromagnetic interference that can compromise the correct operation of electronic equipment.

INSTALLATION POSITION

When choosing the position of installation, comply with the following conditions:

Install only on structures specifically conceived for photovoltaic modules (supplied by installation technicians).

Install Micro-inverter underneath the photovoltaic modules so that they work in the shade. If this condition cannot be met, the inverter could undergo derating.

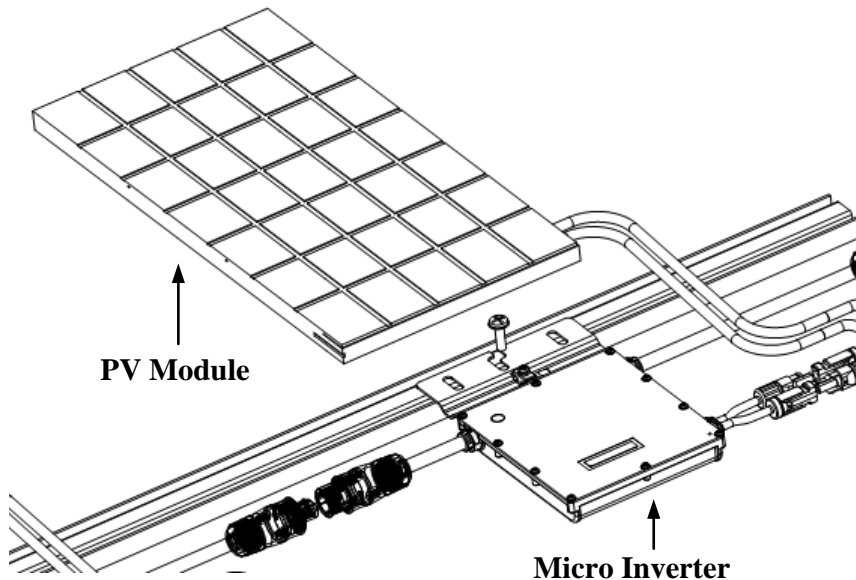

Fig.1. Installation position of Micro-inverter

MOUNTING AND WIRING

INSTALLING DIAGRAM

System Schematic Diagram

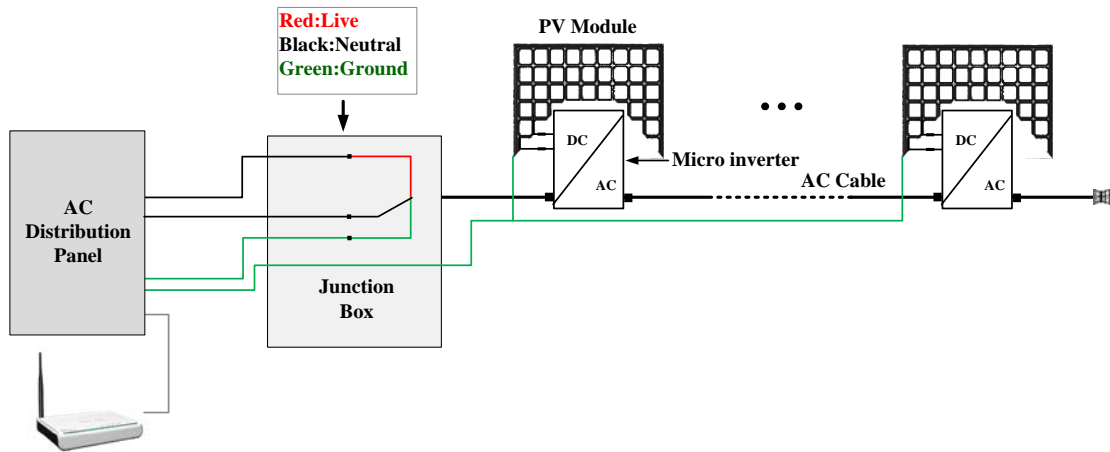

Fig.2. 230Vac single phase

Assembly Diagram

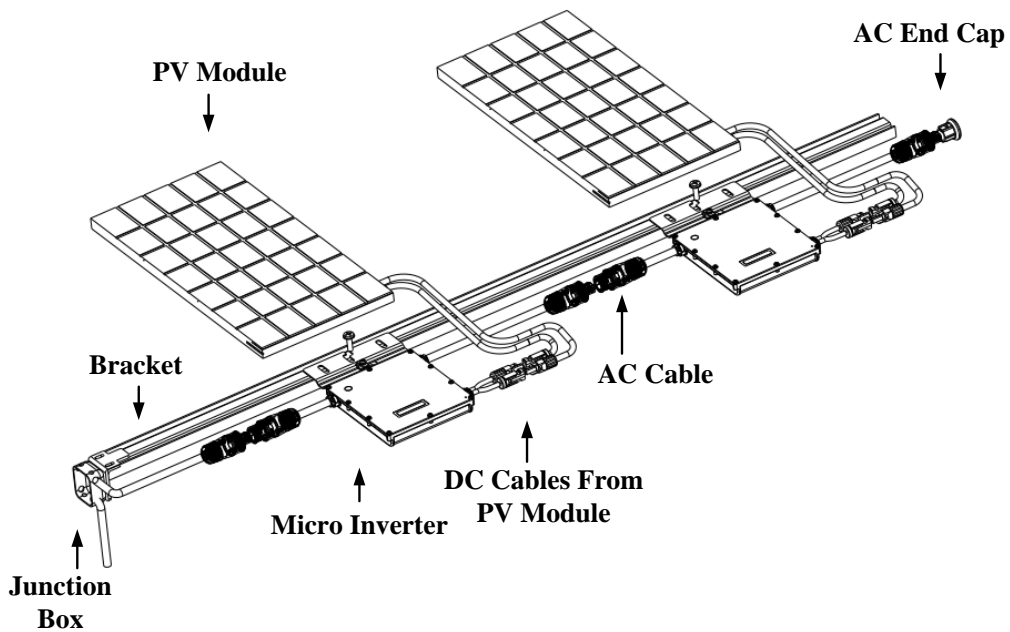

Fig.3. Assembly Illustration

ASSEMBLY INSTRUCTION

Step 1. Install Micro-inverter

Mark the approximate center of each photovoltaic module on the frame and install the Micro-inverter with the logo side facing downwards.



Observe the certification documents concerning the maximum number of Micro-inverters permitted for installation at each cable section!



The Micro-inverter must be under the module, out of long-term exposure to direct sunlight or rain.

Step 2. Connect AC Cable of Micro-inverter

Connect the AC cable of the Micro-inverters. The connectors are coupled correctly when two clicks are heard.

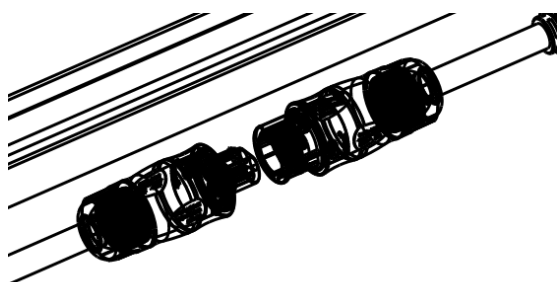

Fig.4. Connect AC Cable of Micro-inverter

Step 3. Protecting Unused Ends

The unused ends of the AC-TRUNK cable must be terminated with the proper end. Fit the appropriate AC-TRUNK END CAP on the unused ends of the AC-TRUNK cable.

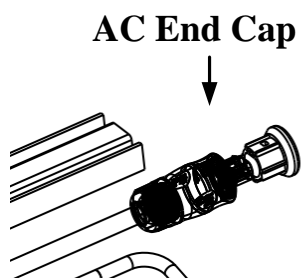

Fig.5. Unused Ends

Step 4. Connecting AC-TRUNK Cables to Junction Box

Connect the AC-TRUNK cables coming from the MICRO inverters to the junction box. Close the junction box after the wiring is complete. Ensure that the seal is tight.

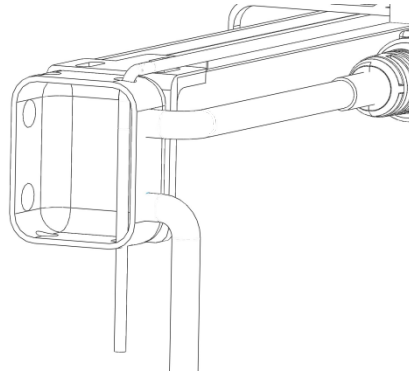

Fig.6. Junction Box



WARNING

To prevent electrical hazards, all the connection operations must be carried out with the equipment disconnected from the grid.



WARNING

All the external connections to the insulated junction box (caps, adapters, etc.) must be made with securely-sealed **Hoymiles** components.

Hoymiles AC cables from the Micro-inverters have three conductors with different colors to identify the function of each conductor:

Red: Live

Black: Neutral

Yellow-Green: Ground



**Pay special attention and ensure not to reverse the phase with the neutral!
The installation technician is responsible for selecting a junction box with the appropriate dimensions and insulation.**



The installation technician is responsible for selecting a cable running between the junction box and the load distribution panel with the appropriate length and cross section.

Step 5. Drawing System Map

Draw a map of the system, affixing the extra label that comes attached to each inverter, on the appropriate position on the diagram (found in the Appendix of this manual).

	Customer Information: ..	Please affix the extra label that comes from each inverter, on the appropriate position on this diagram..			
A					
B					
C					
D					
E					

Fig.7. System Map

Step 6. Install Photovoltaic Modules

Install the photovoltaic modules, and connect the DC cables of the modules to the corresponding DC input side of the Micro-inverter.

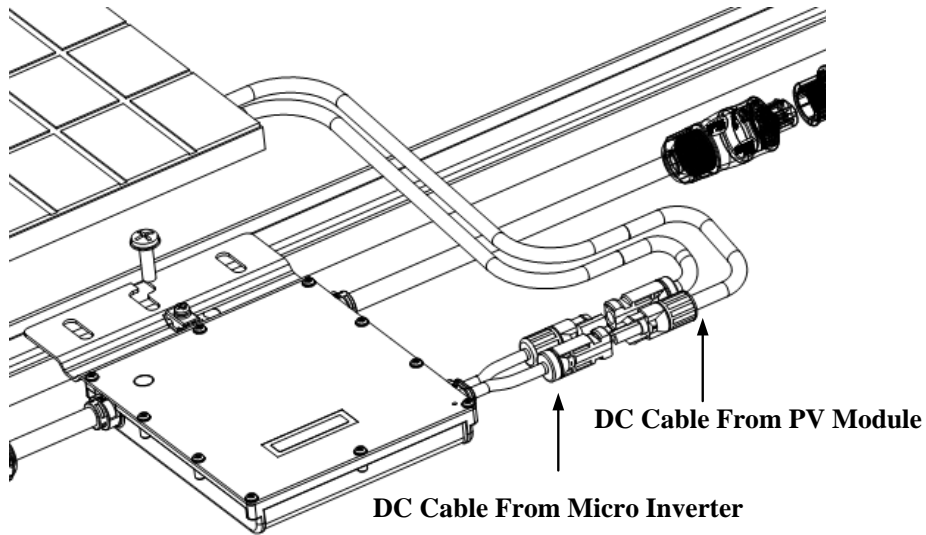

Fig.8. Connect DC Cables



WARNING

The recommended installation need keeping the Micro-inverters underneath the photovoltaic modules, so that the Micro-inverters can operate in the shade. Direct sunlight may cause damage to the Micro-inverters.



WARNING

Each module must be connected to the Micro-inverters with a DC cable having a length of less than 3m.

Step 7. Install CDD

Install the CDD (Concentrator Data Device) and commission

MAINTENANCE GUIDE

ROUTINE MAINTENANCE

- Only authorized personnel are allowed to carry out the maintenance operations and are responsible to report any anomalies.
- Always use the personal protective equipment provided by the employer when carry out the maintenance operation.
- During normal operation, check that the environmental and logistic conditions are correct. Make sure that the conditions have not changed over time and that the equipment is not exposed to adverse weather conditions and has not been covered with foreign bodies.
- DO NOT use the equipment if any problems are found, and restore the normal conditions after the fault removed.
- Conduct an annual inspection on various components, and clean the equipment with a vacuum cleaner or special brushes.



Do not attempt to dismantle the Micro-inverter or make any internal repairs! In order to preserving the integrity of safety and insulation, the Micro-inverters are not designed to allow internal repairs!



The AC output wiring harness (AC drop cable on the Micro- inverter) cannot be replaced. If the cord is damaged the equipment should be scrapped.



Maintenance operations must be carried out with the equipment disconnected from the grid (power switch open) and the photovoltaic modules obscured or isolated, unless otherwise indicated.



For cleaning, DO NOT use rags made of filamentary material or corrosive products that may corrode parts of the equipment or generate electrostatic charges.



Avoid temporary repairs. All repairs should be carried out using only genuine spare parts.

STORAGE AND DISMANTLING



- If the equipment is not used immediately or is stored for long periods, check that it is correctly packed. The equipment must be stored in well-ventilated indoor areas that do not have characteristics that might damage the components of the equipment.
- Take a complete inspection when restarting after a long time or prolonged stop.
- Please dispose the equipment properly after scrapping, which are potentially harmful to the environment, in accordance with the regulations in force in the country of installation.

APPENDIX

TECHNICAL DATA

Model	MI-250	MI-500
Input data(DC)		
Recommended PV module power (STC) range (W)	200-310	200-310
MPPT voltage range (V)	27~48	27~48
Operating voltage range (V)	18~60	18~60
Maximum input voltage (V)	60	60
Maximum input current (A)	10	10×2
Output Data (AC)		
Rated output power (W)	250	500
Rated output current (A)	1.08	2.16
Nominal output voltage	230	230
Nominal frequency	50	50
Power factor	>0.99	>0.99
Output current harmonic distortion	<3%	<3%
Mechanical Data		
Ambient temperature range (°C)	-40 ~ +65	-40 ~ +65
Operating temperature range (°C)	-40 ~ +85	-40 ~ +85
Dimensions (W×H×D mm)	178×153×29	240×155×29
Weight (kg)	1.5	2.2
Enclosure rating	IP67	IP67
Cooling	Natural convection – No fans	Natural convection – No fans
Features		
Communication	Wireless	Wireless
Warranty	15~25 years	15~25 years

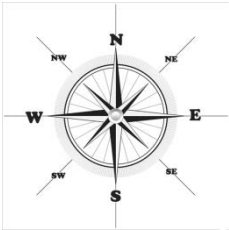
TEMPLATE FOR MAP OF MICRO-INVERTER INSTALLATION

	<p>Customer Information:</p>		<p>Please affix the extra label that comes from each inverter, on the appropriate position on this diagram.</p>		 <p style="text-align: right; margin-top: 5px;">HANGKAI GROUP HOYMILES</p>
	1	2	3	4	5
A					
B					
C					
D					
E					